

Screw-in Cartridge Flow Control Valve with 2-Way Pressure Compensator

SF22A-A2/H

3/4-16 UNF • Q_{max} 21 l/min (6 GPM) • p_{max} 350 bar (5100 PSI)

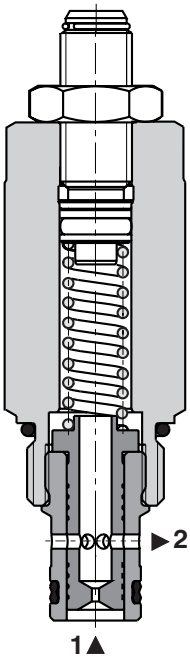

Technical Features

- › Set volumetric flow is independent of load pressure and temperature changes
- › The flow rate depends on the selected flow range and set pressure drop
- › Three flow ranges
- › Fast and smooth response to load changes
- › Precisely manufactured parts and a hardened spool of compensator
- › Possible meter-in, meter-out or bleed-off (serial) connection to an applicator
- › Flow adjustable by allen key or rotating plastic handle
- › In the standard version, the valve is zinc-coated for 240 h protection acc. to ISO 9227. Enhanced surface protection for mobile sector available for the steel parts (ISO 9227, 520 h salt spray)

Functional Description

Screw-in cartridge flow control valve with 2-way pressure compensator is designed for speed control of actuator in applications, where the minimum fluctuation of velocity is acceptable during load changes. The 2-way pressure compensator spool maintains constant pressure drop on the valve by throttling and thus a constant flow in the flow direction 1 → 2. The volumetric flow is independent of pressure changes in ports 1 and 2. Flow adjustment, in the range given by the nozzle diameter, is performed by changing the pressure drop, by means of spring compression with adjusting screw. The regulated flow increases with clockwise rotation of the adjusting screw. In the opposite flow direction 2 → 1 the valve works as a flow restrictor and the pressure compensator spool is inactive.

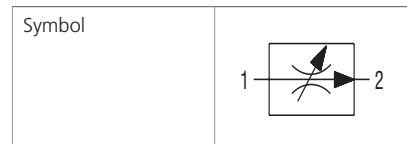

Technical Data

Valve size / Cartridge cavity		3/4-16 UNF-2A / A2 (C-8-2)			
Nominal flow rates		1	2	6	12
Adjustment range	l/min (GPM)	0.1-0.6 (0.02 - 0.2)	0.5-3.2 (0.1-0.8)	3-8.5 (0.8-2.3)	8-21 (2.1-5.6)
Max. operating pressure	bar (PSI)	350 (5080)			
Fluid temperature range (NBR)	°C (°F)	-30 ... +100 (-22 ... +212)			
Fluid temperature range (FPM)	°C (°F)	-20 ... +120 (-4 ... +248)			
Weight	kg (lbs)	0.19 (0.42)			

		Datasheet	Type
General information		GI_0060	Products and operating conditions
Valve bodies	In-line mounted	SB_0018	SB-A2-*
	Sandwich mounted	SB-04(06)_0028	SB-*A2*
Cavity details / Form tools		SMT_0019	SMT-A2*
Spare parts		SP_8010	

Characteristics measured at $v = 32 \text{ mm}^2/\text{s}$ (156 SUS)

Regulated flow related to input pressure

Flow direction 1 - 2 (regulated flow)

Flow rate 1

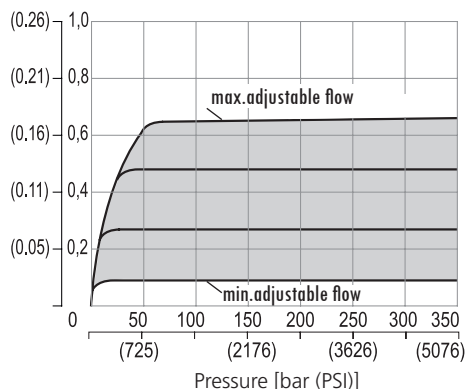

Flow rate 2

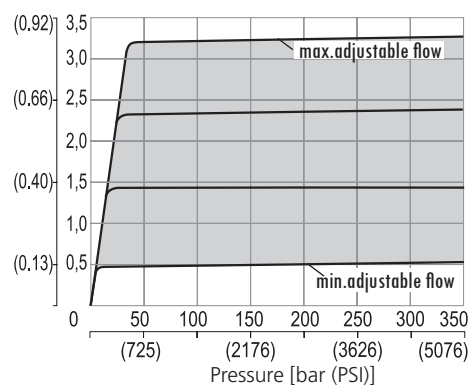

Flow rate 6

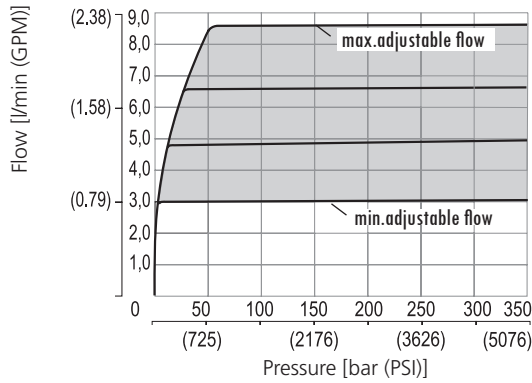

Flow rate 12

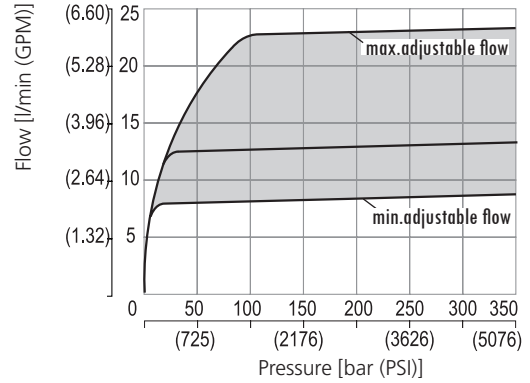

Characteristics measured at $v = 32 \text{ mm}^2/\text{s}$ (156 SUS)

Pressure drop related to flow rate

Flow direction 2 - 1 (throttling without compensation)

Flow rate 1, 2

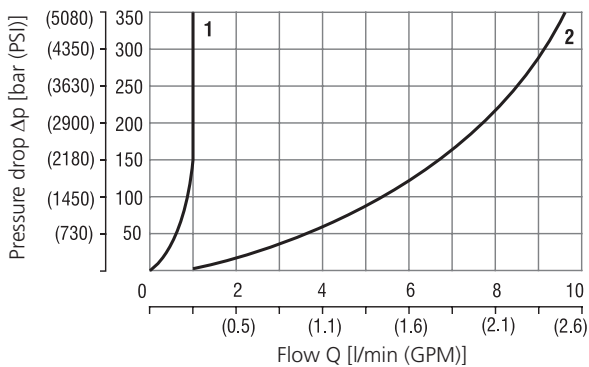

Flow rates 6, 12

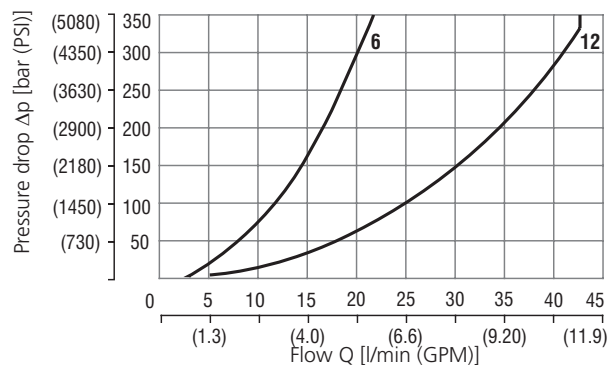

Dimensions in millimeters (inches)

Model S

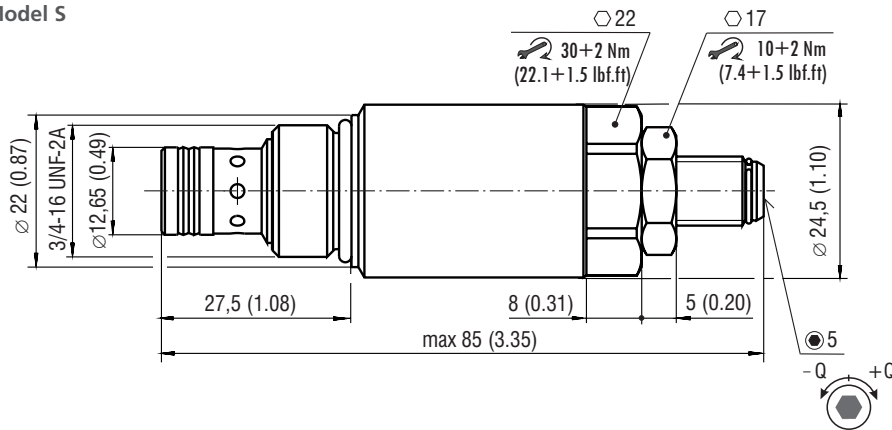

Model RS

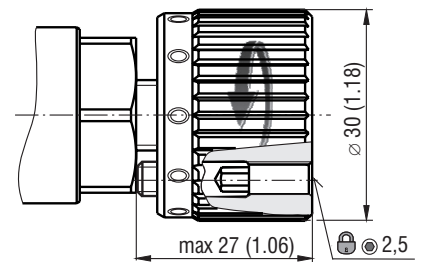

Ordering Code

SF22A-A2/H [] [] [] - []

2-Way flow regulator, pressure compensated

Valve cavity
3/4-16 UNF-2A (C-8-2)

Model
High performance

Flow rate		
0,1 - 0,6 l/min	(0.02 - 0.2 GPM)	1
0,5 - 3,2 l/min	(0.1 - 0.8 GPM)	2
3 - 8,5 l/min	(0.8 - 2.3 GPM)	6
8 - 21 l/min	(2.1 - 5.6 GPM)	12

Surface treatment
A zinc-coated (ZnCr-3), ISO 9227 (240 h)
B zinc-coated (ZnNi), ISO 9227 (520 h)

No designation
V

Seals
NBR
FPM (Viton)

Adjustment option
S allen key (hex. 5), without protective cap
RS hand screw, metal