

EL6

Technical Features

- › Digital electronics for open-loop control of a single proportional valve solenoid - plug-in version
- › Independent adjustments (including ramp up and ramp down)
- › Large, easy-to-use adjustments, readout on a 3-digit, 7-segment LED display
- › Display of actual values direct adjustment (current & voltage)
- › User selectable input type through menu setup (ex: 0 to 5V, 0 to 10 V, 4 to 20 mA)
- › Wide range of supply voltage and ramp time (0 to 99.5 sec)
- › Simple control with analog input, locally supplied reference voltage
- › Energy efficient PWM circuit, no heat sink required
- › Electronic limiting circuit/ short-circuit proof
- › Reverse polarity, command input protection
- › Load can be connected and disconnected live
- › Mounting: DIN 43650-A/ISO 4400 solenoid terminal

Functional Description

The control electronics is intended for the open-loop control of proportional valves with one solenoid. Its great advantage is its miniature design in form of a socket for a standardized DIN connector base.

The unit supplies a variable current proportional to the reference signal, independently of temperature or load impedance variations.

To optimize valve control and minimize valve hysteresis the unit contains a PWM stage to supply the solenoid.

The card's top surface contains two revolving selectors, a terminal block to connect supply and control wires, and a three-digit LED display.

The selector marked as "SELECT" is used to select the parameter to be adjusted. The second selector, marked as "ADJUST", is used to set the desired value. In basic operational mode, the display shows an input/output parameter value; in adjustment mode, the selected parameter abbreviation and the value being set up are indicated. The correct input signal type must be selected before operation.

Technical Data

Solenoid data			
Operating voltage	V	9... 36 DC	
Max. output current	A	3	
Control signal type		0 - 5 [V], 0 - 10 [V], 4 - 20 [mA]	
Adjustable range of ramp functions	s	0.05... 99.5	
PWM / Dither frequency	Hz	40 - 450	
Linearity	%	1	
Operating ambient temperature	°C (°F)	-40... +75 (-40... +167)	
Recommended cross-section of lead-in wires	mm ²	0.5... +0.75	
Enclosure type of the solenoid to EN 60529		IP65	
Mass	kg (lbs)	0.13 (0.29)	
	V	12	24
Max. coil excitation current of proportional directional valves	PRM2-04	(Coil 16186100) ... 1.7	(Coil 16186200)... 0.8
	PRM2-06	(Coil 16187500) ... 1.6	(Coil 16186800)... 1.0
	PRM6-10	(Coil 16195800) ... 1.9	(Coil 16196200)... 1.1
Attention: A cable with a circular cross-section and outside diameter of 4 to 6 mm should be used for the electronics supply, only this way the declared degree of IP protection can be secured.			

Block Diagram

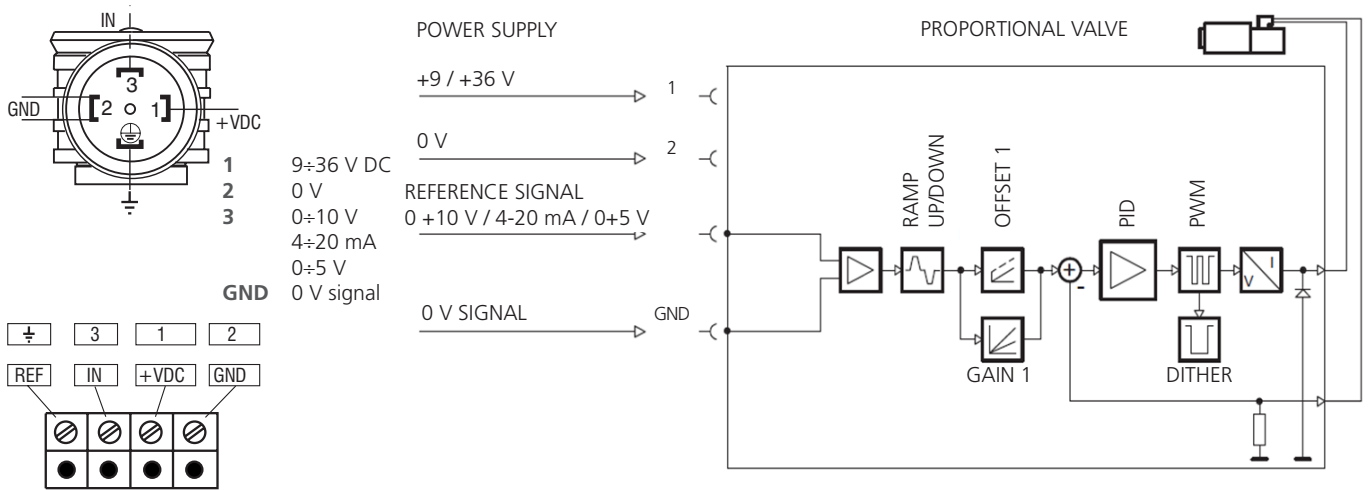

Wiring Diagram

1) EXTERNAL INPUT SIGNAL CONNECTION ("in" set to "10")

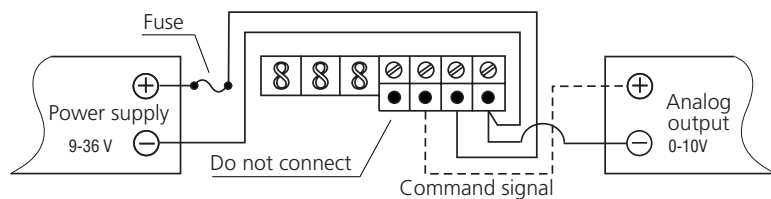

2) POTENTIOMETER CONNECTION ("in" set to "5")

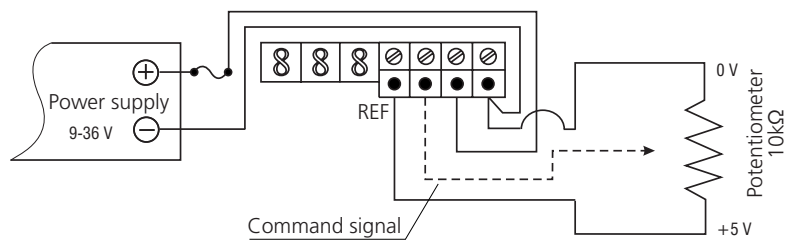

3) RAMP UP & DOWN ONLY OPERATION ("in" set to "5")

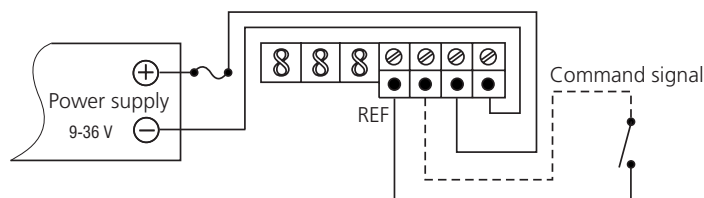

4) EXTERNAL INPUT SIGNAL CONNECTION 4-20 mA ("in" set to "420")

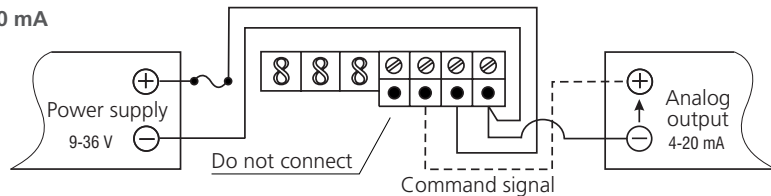

5) TWO WIRE TRANSMITTER INPUT CONNECTION 4-20 mA ("in" set to "420")

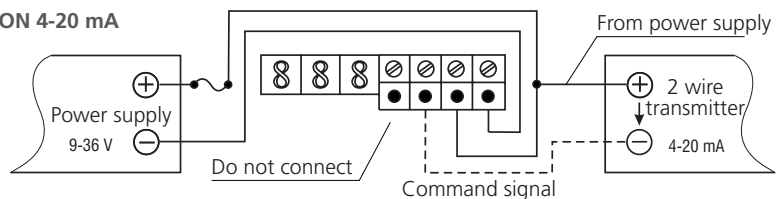

Installation note:

1. The power supply voltage on the connector must be higher than the rated working voltage of the solenoid to be controlled.
2. The IP rating depends on proper installation by the user. A round cable of 4 - 6 mm (0.15 - 0.25 in) diameter must be used.
3. For „0 to 5 V DC“ and for „0 to 10 V DC“ command input drivers, it is recommended to use independent negative conductors for power supply and analog output channel (PLC/PC) to maintain command signal accuracy due to voltage drop on long cables.

Set up Procedure

Attention:

- Prior to setting up parameters, you must select the proper input signal type for your system.
The standard is preset to an input signal from 0 to 10 V.
 - Applying an improper input signal type may damage the driver unit and may cause the system to fault to the „Error“ status mode.
1. At power up, the display will show either the output current signal or the input signal (default display setting shows the output signal).
The decimal point will be flashing.
 2. Rotate „SELECT“ to enter the set-up mode. Parameter abbreviation is indicated on the display.
 3. When you reach the setting you want to modify, rotate „ADJUST“ up or down to the desired value.
 4. To modify another setting, rotate „SELECT“ again and repeat.
 5. The driver is fully functional during the set-up procedure with any adjustments taking effect immediately.
 6. In order to write the new settings in the memory and return to normal mode of operation, rotate „SELECT“ until the display shows „SR“ and then rotate „ADJUST“ from 0 to 1 or wait for 100 seconds.
 7. If you do not want to save the new settings you have just modified, you must disconnect the Driver from the power supply before the end of the 100 seconds to restore previous settings.
 8. After saving the parameters to memory, the decimal point will be flashing and the driver display will be back showing either the output current signal or input signal depending on your „di“ selection.
 9. To start over completely, you can restore the factory settings by rotating „SELECT“ to „rFP“ and then rotate „ADJUST“ up from 0 to 10 for the display to reset.
(NOTE for Step 9: You may have to adjust your input signal type again if you reset to factory settings).

Settings and Range

Parameter Abbreviation	Parameter	Adjustable Range
Hi	HIGH, maximum current output	0.20 - 3 A
Lo	LOW, minimum current output	0 - 2.99 A
rUP	RAMP UP, time for output to increase from min. to max.	0 - 99.5 s
rdn	RAMP DOWN, time for output to decrease from max. to min.	0 - 99.5 s
Cdb	dead band – output current to the coil is zero, until the control signal exceeds a threshold of insensitivity (the threshold is expressed in % of the control signal maximum value)	0 - 5 %
dFr	DITHER FREQUENCY, 40 (40Hz) to 450 (450Hz)	40 - 450 Hz
in 5 10 420	Input control signal type selection - Voltage signal - Voltage signal - Current signal	0 - 5 V 0 - 10 V 4 - 20 mA
di 0 1	Signal value indication for checking or problem solving purposes - Command signal [V] or [mA] - Output signal [A] Flashing decimal point is an indicator for present display mode: - Fast flashing decimal point, several flashes per second indicates – command signal (di = 0) - Slow flashing decimal point, 1 per second indicates – output signal (di = 1) - No flashing decimal point or no decimal point indicates display in SETTING/ADJUST	
SR	SAVE SETTINGS	
rFP	RESET FACTORY PARAMETERS	
Err 0 1 2	ERROR DETECTION STATE, short circuit, reverse polarity protection and detection - Error 0 - no errors - Error 1 - overcurrent in driver likely due to short circuit in solenoid - Error 2 - current exceeding 20 mA in „4 to 20 mA“ input mode	
CLr	CLEAR ERROR, clears driver of error state	

Note: When adjusting the Hi and Lo parameters, the Hi parameter value cannot be adjusted below the Lo parameter value as well the Lo parameter value cannot exceed the Hi parameter value.

Optional features

- Pcd:** PASSWORD, adjust code for password protection settings for lock or unlock
Loc: LOCK, locks driver to LOCKED state with password set in **Pcd**
UnL: UNLOCK, unlocks driver with correct password set in **Pcd**. **Only available in LOCKED mode!**

Range Characteristics

Adjustment of maximum:
(High) / parameter „Hi“
maximum current output, **0.20 to 3.00 A**

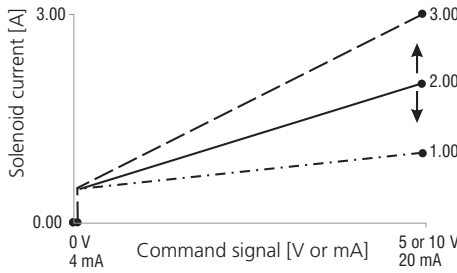

Adjustment of minimum:
(Low) / parameter „Lo“
maximum current output, **0.00 to 2.99 A**

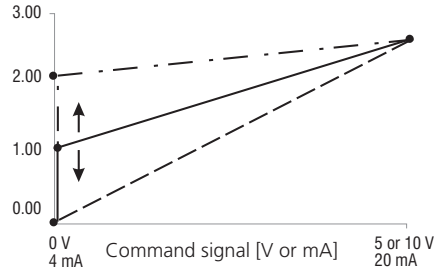

Adjustment of ramp up:
(Ramp up) / parameter „rUP“ (from min. to max.)
time for output to increase, **0 to 99.5 s**

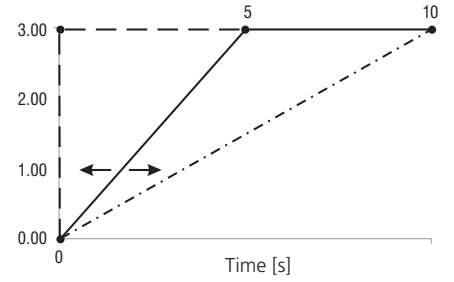

Adjustment of ramp down:
(Ramp down) / parameter „rdn“ (from max. to min.)
time for Output to Decrease **0 to 99,5 s**

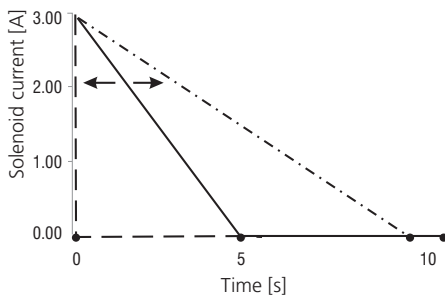

Adjustment deadband:
(Command deadband) / parameter „Cdb“
output disabled if command signal
less than deadband
0 to 5 % of the maximum command signal

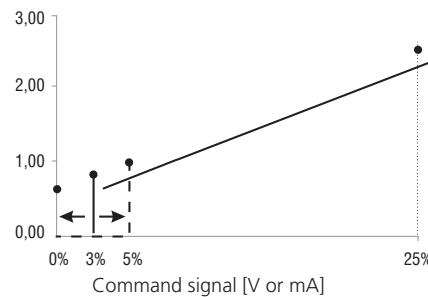

Dither Frequency
(Dither frequency) / parameter „dFr“
Frequency selectable in a range from **40 to 450 Hz**

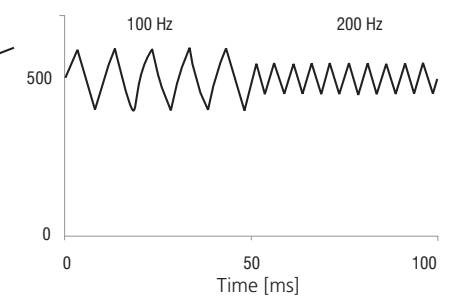

Dimensions in millimeters (inches)

